

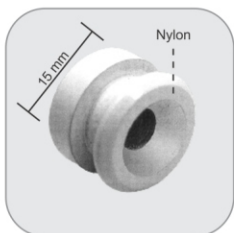

WFE

WORLD FER

**FERRAGENS PARA
VIDROS TEMPERADOS**



1000 - Engate para corrente em alvenaria
Enganche en albañilería para cadena

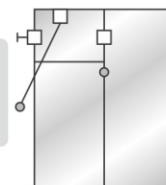

1001 - Botão de correção com engate
Botón de corrección con enganche

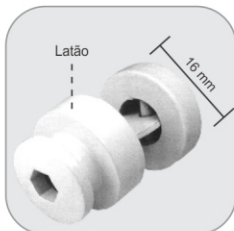
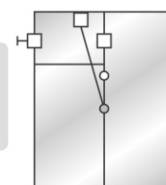

1001L - Botão de correção lâmina com engate
Botón de corrección lámina con enganche

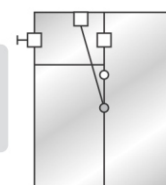

1002 - Botão de correção com parafuso
Bóton de corrección con tornillo

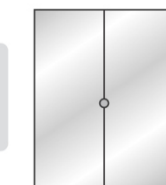

1002L - Botão de correção lâmina
Bóton de corrección con lámina

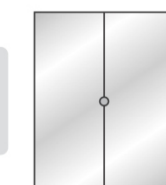

1003 - Corrente para basculante
Cadena para ventana pivotante

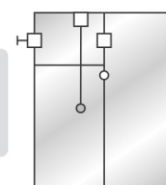

1003CA - Cabo de aço para basculante (montado)
Cable de acero para ventana pivotante

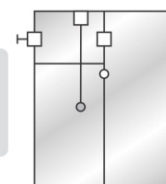

1003CM - Cordão de polipropileno p/ basculante + argola
Cordón para ventana pivotante + argolla

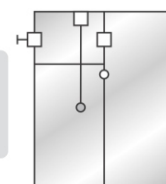



1006 - Parafuso sistema "só vidros"
Tornillo para sistema sólo vidrios

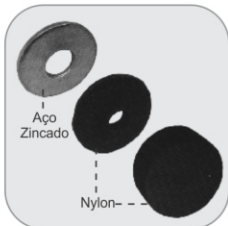
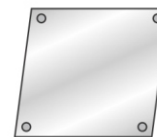

1007 - Acabamento "só vidro" (arruela, junta e tampa)
Acabamiento "sólo vidrio" (arandela, aclopa y tapa)

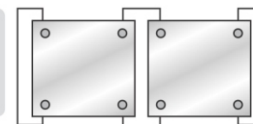

1009 - Pivô para dobradiça 1101, 1230 e 1231
Pivote en acero inoxidable para bisagra 1101, 1230 y 1231



1009G - Max pivô superior para dobradiça 1101G
Pivote mayor superior para bisagra 1101G

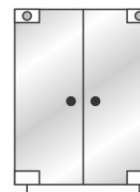

1010 - Botão de acabamento p/ puxador 1680
Tornillo para sujetar agarradera 1680

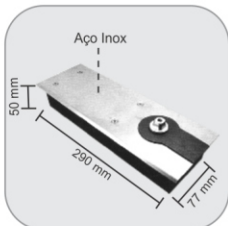
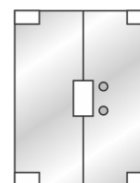

1012 - Mola Hidráulica de piso
(Cierra puertas) bisagra hidráulica de piso

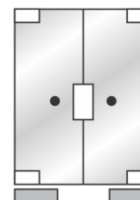

1012S - Mola hidráulica aérea
(Cierra puertas) bisagra hidráulica aérea

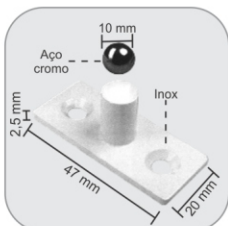
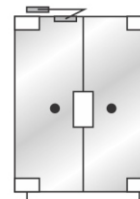

1014 - Pivô inferior para dobradiça 1102
Pivote inferior para bisagra 1102

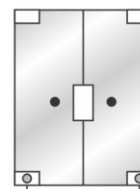

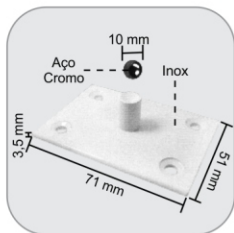

1014G - Max pivô inferior para dobradiça 1102G
Pivote mayor inferior para bisagra 1102G

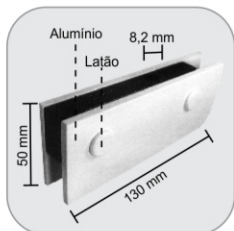
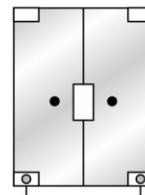

1101 - Dobradiça pivotante superior para 1009
Bisagra superior para puerta con pivote 1009

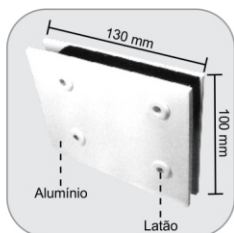
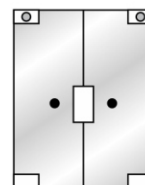

1101G - Max dobradiça superior para 1009G
Bisagra mayor para puerta con pivote 1009G

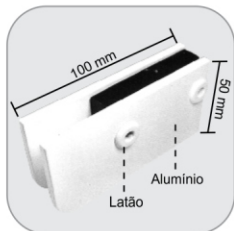
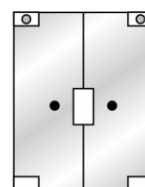

1101M - Mini dobradiça pivotante superior para 1014
Bisagra pequeña superior para puerta con pivote 1014

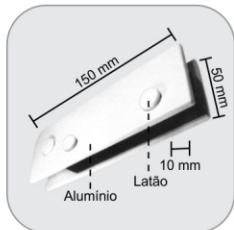
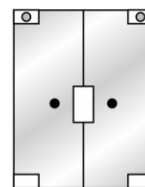

1102 - Dobradiça pivotante inferior para 1014
Bisagra inferior para puerta con pivote 1014

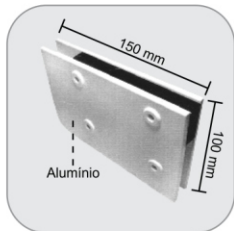
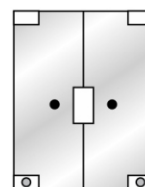

1102G - Max dobradiça pivotante inferior para 1014G
Bisagra mayor inferior para puerta con pivote 1014G

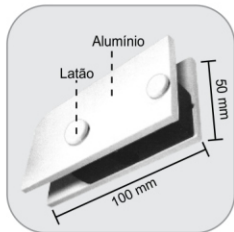
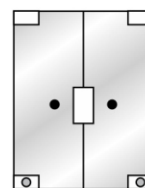

1102M - Mini dobradiça pivotante inferior para 1014
Bisagra pequeña inferior para puerta con pivote 1014

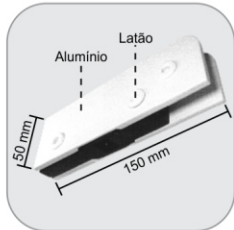
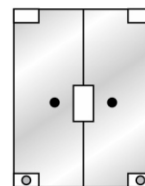

1103 - Dobradiça inferior para mola de piso
Bisagra inferior para cierra puertas 1012

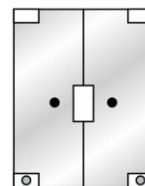

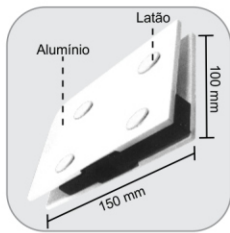

1103G - Max dobradiça inferior para mola de piso
Bisagra mayor para cierra puerta 1012

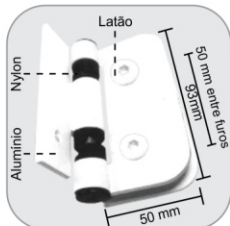
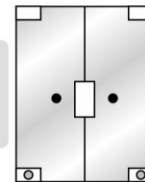

1114 - Dobradiça automática para box
Bisagra automática para box (compartimiento de ducha)

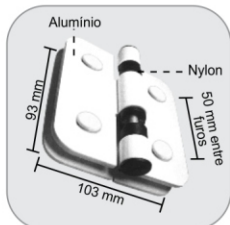

1114D - Dobradiça dupla automática direita
Bisagra automática para box vidro y vidrio derecha

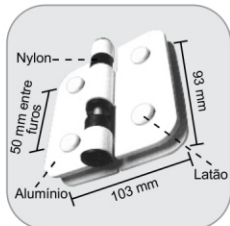
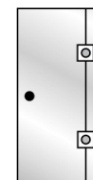

1114E - Dobradiça dupla automática esquerda
Bisagra automática para box vidro y vidrio izquierda

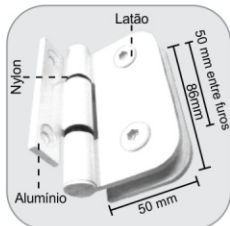
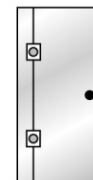

1115 - Dobradiça simples pra box
Bisagra simple para box (compartimiento de ducha)

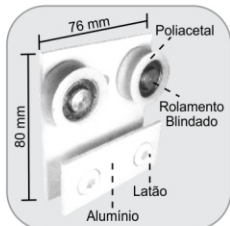

1122 - Carrinho duplo para 1030 (portas até 80 Kg)
Carretilla doble para perfil 1030 (puerta hasta 80Kg)

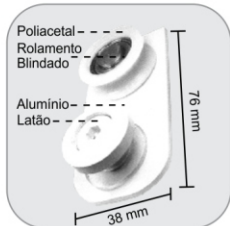
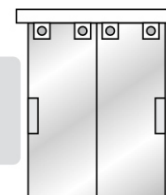

1122M - Mini carrinho simples (1 furo) p/ 1030 (portas até 20 Kg)
Carretilla pequeña (1 agujero) para perfil 1030 (puertas hasta 20 Kg)

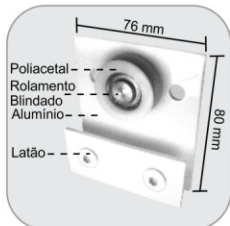
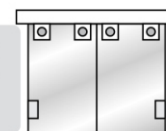

1122S - Carrinho simples (2 furos) p/ 1030 (portas até 30Kg)
Carretilla (2 agujeros) para perfil 1030 (puertas hasta 30 Kg)

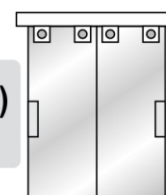

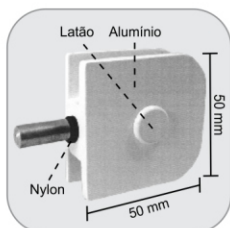

1123 - Dobradiça para basculante 50 x 50 mm
Bisagra vidrio y vidrio para ventana pivotante

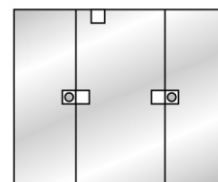

1125 - Roldana para porta e janela de correr
Polea para puerta y ventana de correr

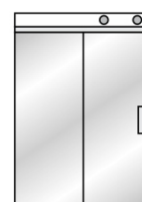

1125D - Roldana dupla com balancim
Polea doble con balancín

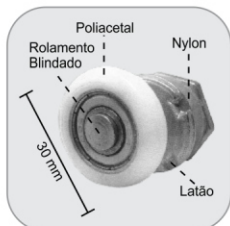
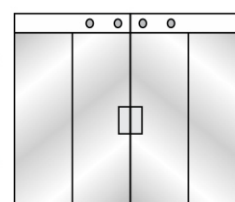

1125E - Roldana para box excêntrica
Polea para box excentrica

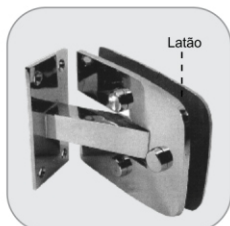
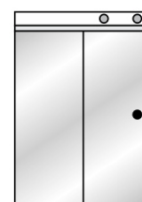

1128A - Dobradiça V/A p/ portas em arco para 1102/1103
Bisagra lateral p/ puerta en arco con bisagra inferior 1102/1103

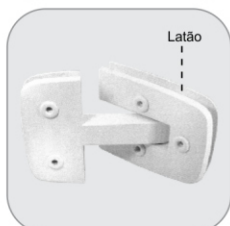
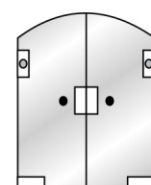

1128C - Dobradiça V/V p/ portas em arco para 1102/1103
Bisagra lateral vidrio y vidrio p/ puerta en arco con bisagra inf. 1102/1103

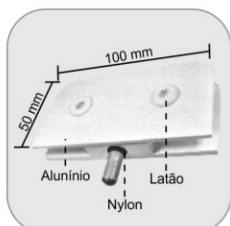
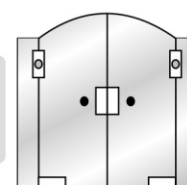

1130 - Dobradiça p/ basculante c/ pino 50 x 100 mm
Bisagra vidrio y vidrio para ventana pivotante

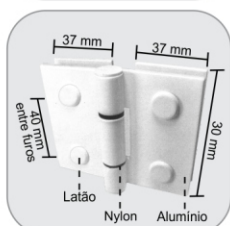
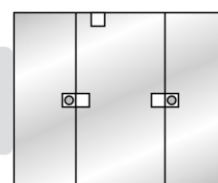

1131 - Dobradiça maxin-ar V/V 40 mm entre furos
Bisagra vidrio y vidrio p/ ventana de preyección (40 mm entre agujeros)

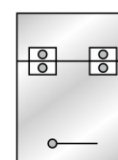

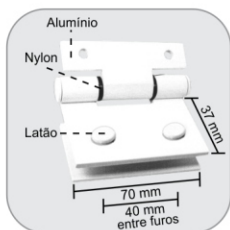

1132 - Dobradiça maxim-ar V/A 40 mm entre furos
Bisagra V/A para ventana de proyección (40 mm entre agujeros)

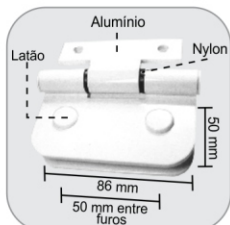
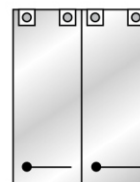

1133 - Dobradiça maxim-ar V/A 50 mm entre furos
Bisagra V/A para ventana de protección (50 mm entre agujeros)

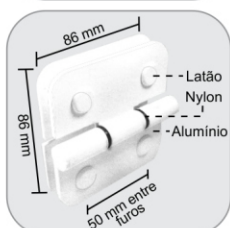
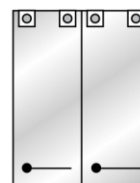

1134 - Dobradiça maxim-ar V/V 50 mm entre furos
Bisagra V/V para ventana de proyección (50 mm entre agujeros)

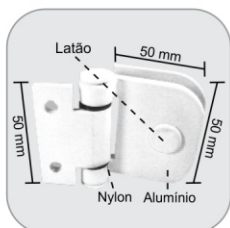
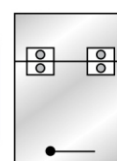

1136 - Dobradiça simples pequena para janela
Bisagra lateral pequena para ventana

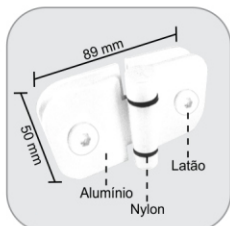
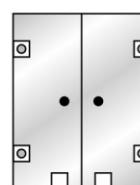

1137 - Dobradiça dupla pequena para janela
Bisagra lateral pequena vidro y vidrio para ventana

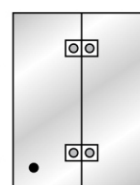

1141 - 2 mini dobradiças pivô de pressão (6 mm) para rack
Bisagra pequena con pivote de presión (vidrio 6mm) para mueble

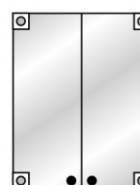

1150 - Roldana quadrupla para trilho 1030
Polea cuadruple para perfil 1030

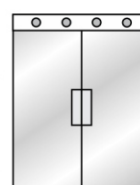

1150S - Roldana dupla para trilho 1030 (box)
Polea doble para perfil 1030 (box)

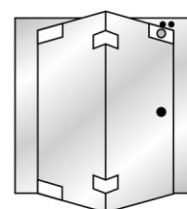

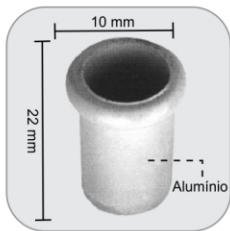

1200 - Capuchinho para trinco e fechadura
Contra traba y cerradura de piso

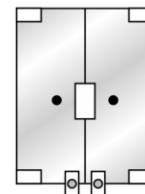

1203 - Suporte de bandeira para dobradiça 1101
Soporte para banderola e bisagra 1101

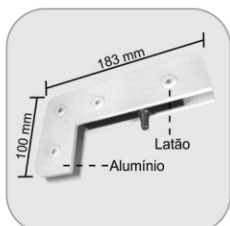
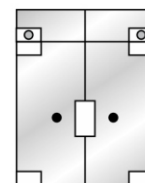

1209 - Facão simples para bandeira e fixo para 1101
(Pistola) soporte "L" para bisagra 1101 y banderola

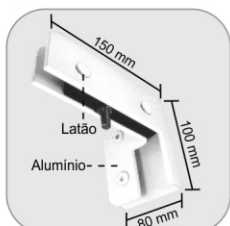
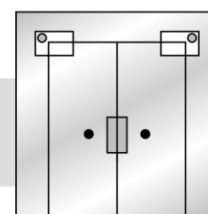

1209D - Facão direito à 90° para 1101
Soporte "L" derecho en 90° para bisagra 1101 y banderola

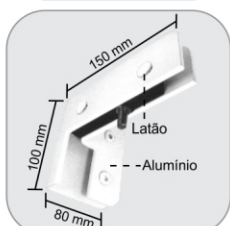
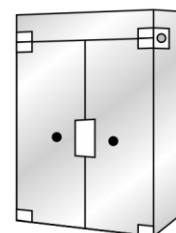

1209E - Facão esquerdo à 90° para 1101
Soporte "L" izquierdo en 90° para bisagra 1101 y banderola

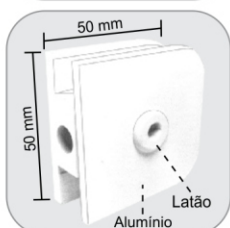
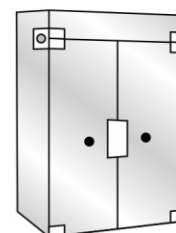

1230 - Dobradiça bucha para basculante 50 x 50 mm
Bisagra buje para ventana pivotante 50 x 50 mm

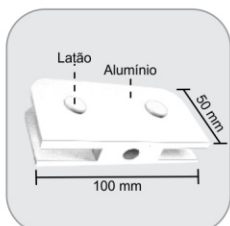
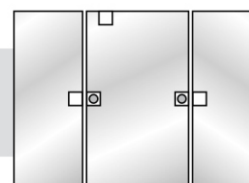

1231 - Dobradiça bucha para basculante 50 x 100 mm
Bisagra buje para ventana pivotante 50 x 100 mm

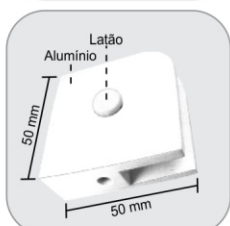
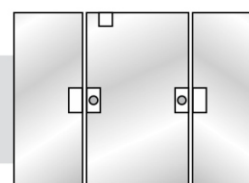

1302 - Suporte de canto
(Esquinero) soporte de esquina

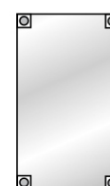

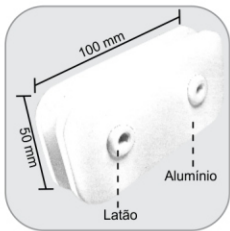

1305 - Suporte central sem núcleo
Soporte central sin núcleo

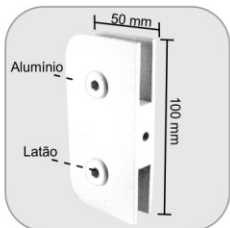
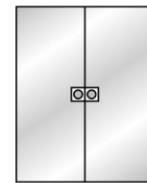

1306 - Suporte para união de 2 vidros
Soporte para unión de 2 vidrios

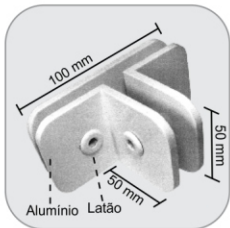
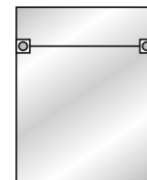

1307 - Suporte sem núcleo para união de 3 vidros em T
Soporte "T" sin núcleo para unión de 3 vidrios

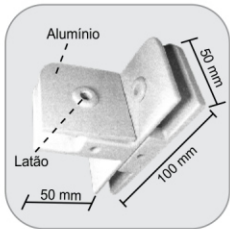
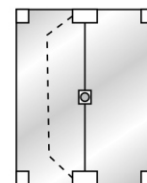

1308 - Suporte com núcleo para união de 3 vidros em T
Soporte "T" con núcleo para unión de 3 vidrios

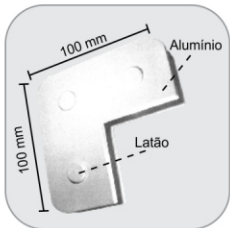
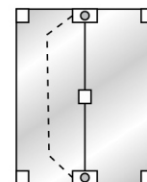

1310 - Suporte sem núcleo para união de 3 vidros
Soporte triple

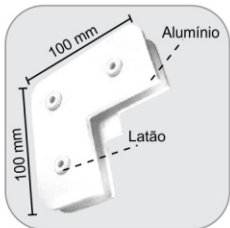
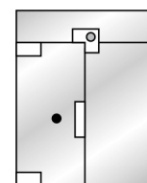

1315 - Suporte sem núcleo com batedeira p/ união de 3 vidros
Soporte triple con tope

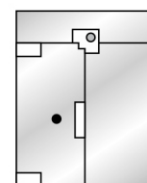

1316 - Suporte sem núcleo para união de 4 vidros
Soporte cuadruple

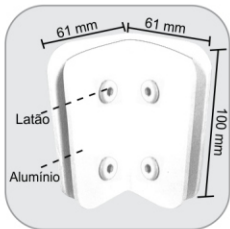
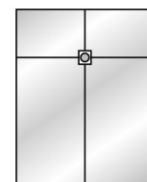

1319 - Suporte para união de 4 vidros a 90°
Soporte cuadruple en 90°

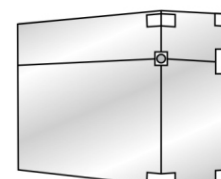

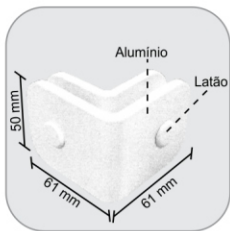

1320 - Suporte central s/ núcleo p/ união de 2 vidros a 90°
Suporte central sin núcleo para unión de 2 vidrios en 90°

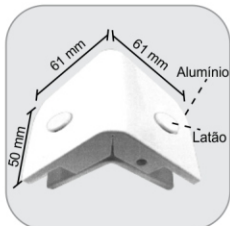
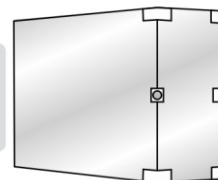

1321 - Suporte piso/teto c/ núcleo p/ união de 2 vidros a 90°
Suporte piso y techo con núcleo para unión de 2 vidrios en 90°

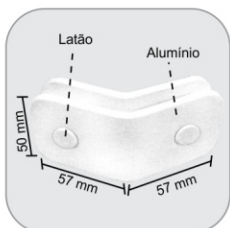
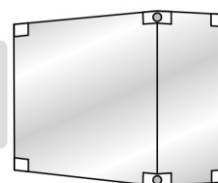

1321A - Suporte central s/ núcleo p/ união de 2 vidros a 135°
Suporte central sin núcleo para unión de 2 vidrios en 135°

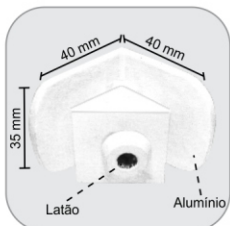
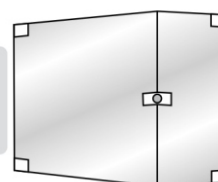

1322 - Suporte de centro c/ núcleo p/ união de 2 vidros a 90°
Suporte central con núcleo para unión de 2 vidrios en 90°

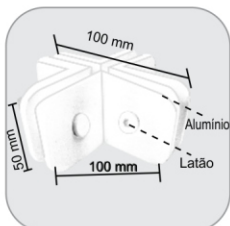
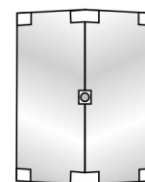

1323 - Suporte p/ união de 4 vidros perpendiculares
Suporte para unión de 4 vidrios perpendiculares

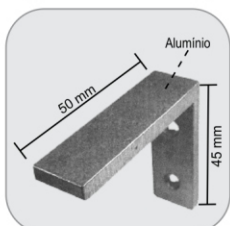
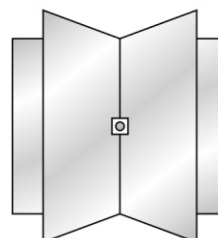

1325 - Suporte para fixação trilho 1030 na parede
Suporte para fijación del perfil 1030 en la pared

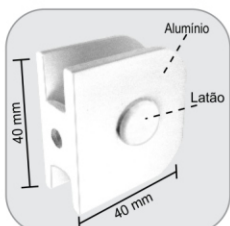
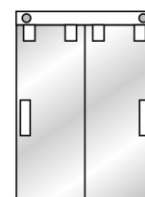

1326 - Mini suporte para fixação 40 x 40 mm
Suporte pequeño central 40 x 40 mm

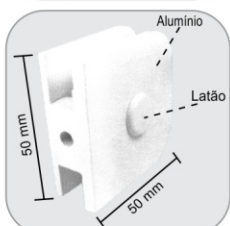
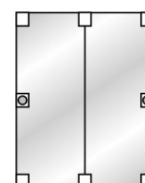

1329 - Suporte central para fixação 50 x 50 mm
Suporte central 50 x 50 mm

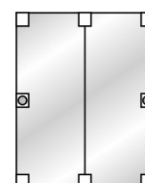

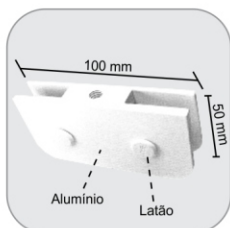

1332 - Suporte central com rosca para 1150S (box)
Suporte central para polea 1150S (box)

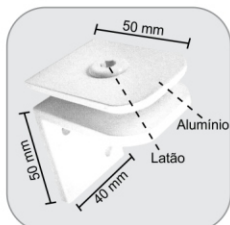
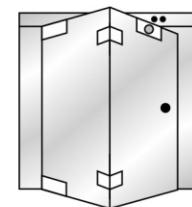

1333 - Suporte para prateleiras
Suporte para repisas

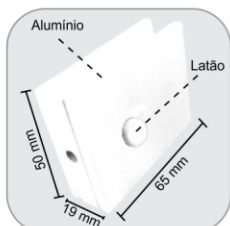
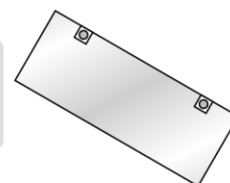

1334 - Grapa para sacada 50 x 65 mm (sem recorte)
Grapa para balcón 50 x 65 mm (sin recorte)

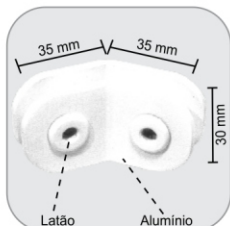
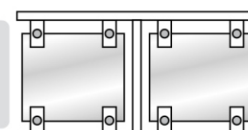

1335 - Suporte para união de 2 vidros a 135°
Suporte para unión de 2 vidrios en 135°

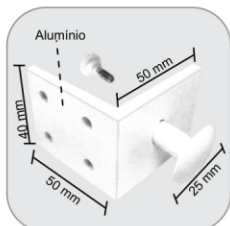
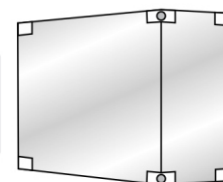

1336 - Cantoneira completa p/ sistema "só vidro" c/ 1006
Esquinera completa para sistema "sólo vidrio" con 1006

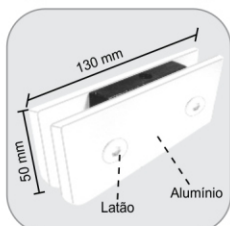
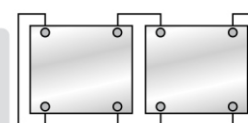

1340 - Suporte de canto com rosca p/ roldana 1150
Suporte de esquina para polea 1150

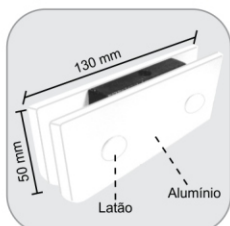
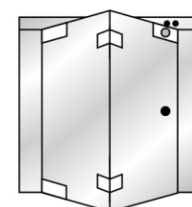

1341 - Suporte de centro com rosca p/ roldana 1150
Suporte central para polea 1150

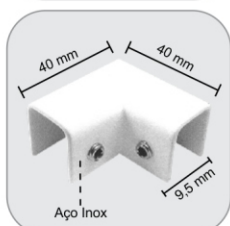
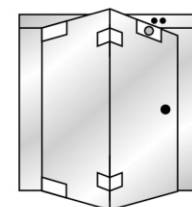

1350 - Suporte superior p/ box a 90° (sem recorte)
Suporte superior para box en 90° (sin recorte)

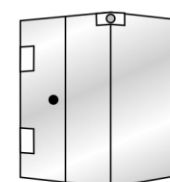

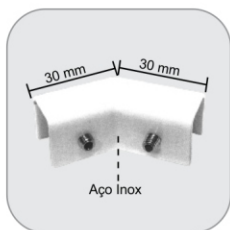

1351 - Suporte superior p/ box a 135° (sem recorte)
Soporte superior para box en 135° (sin recorte)

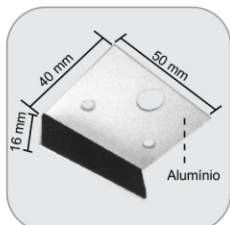
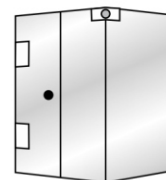

1400 - Batedeira para trinco de basculante
Tope para traba de ventana pivotante

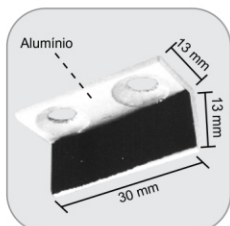
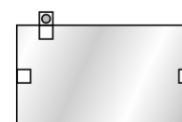

1401 - Batedeira simples
Tope simple para puerta pivotante

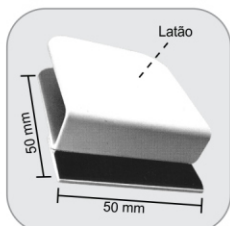
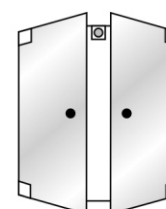

1402 - Batedeira sem núcleo de pressão
Tope sin núcleo para banderola

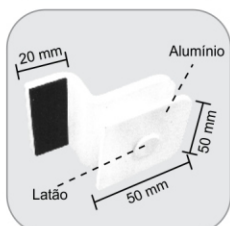
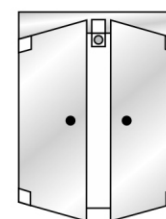

1403 - Batedeira sem núcleo p/ porta sanfonada
Tope sin núcleo para puerta sistema camarón

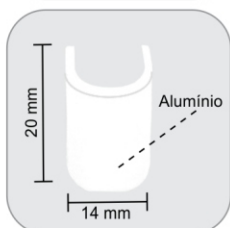
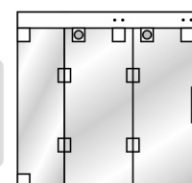

1408 - Contra trinco para 1519 e 1521
Contra traba 1519 y 1521

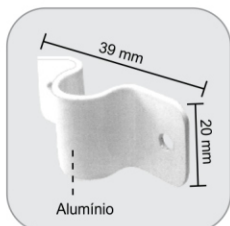
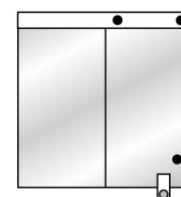

1408A - Contra trinco com aba para 1519 e 1521
Contra traba con ala para 1519 y 1521

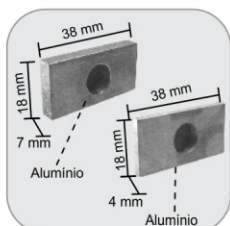
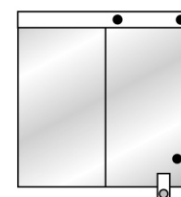

1410 - Contra trinco c/ 4mm auto-adesivo para 1813J
1411 - Contra trinco c/ 7mm auto-adesivo para 1813P

Contra traba con 4mm auto-adhesivo para 1813J
Contra traba con 7mm auto-adhesivo para 1813P

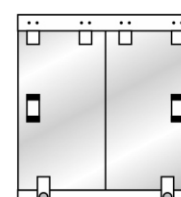

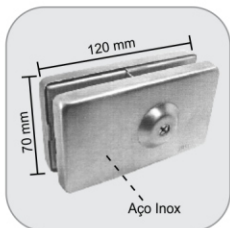

1500 - Fechadura de encaixar p/ porta pivotante
Cerradura de encaje para puerta pivotante

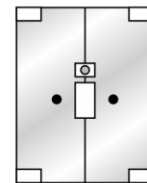

1500A - Trava de porta de correr com encaixe interno
Traba de encaje interna para puerta de correr

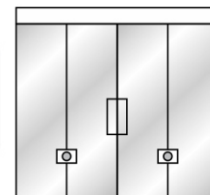

1500B - Fechadura de encaixar p/ porta de vidro de correr
cerradura de encaje para puerta de correr

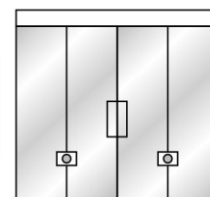

1501 - Fechadura com trinco rolete
Cerradura con traba de atornillar

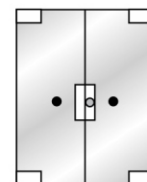

1502 - Trinco com rolete de um lado
Traba de atornillar de un solo lado

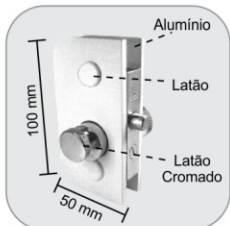
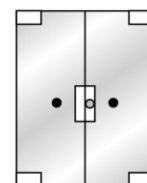

1503 - Trinco com rolete duplo
Traba de atornillar de los dos lados

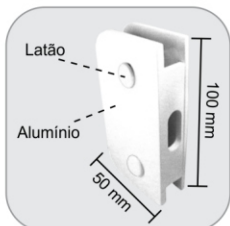
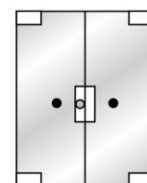

1504 - Contra fechadura para 1520/1550
Contra cerradura para 1520 y 1550

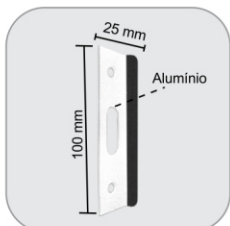
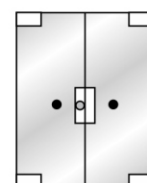

1504A - Batedeira em alvenaria para 1520 e 1550
Tope en albañilería para 1520 y 1550



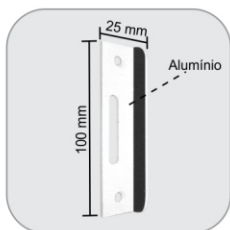

1504AF - Batedeira em alvenaria para 1520BF
Tope en albañilería para 1520BF

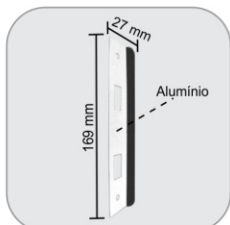
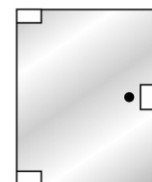

1504ATD - Batedeira em alvenaria p/ 1520TA direita (vista externa) *Tope en albañilería p/ 1520TA derecha (vista externa)*

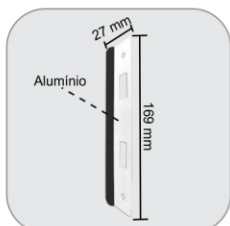
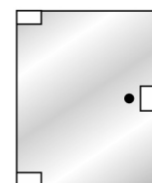

1504ATE - Batedeira em alvenaria p/ 1520TA esquerda (vista externa) *Tope en albañilería p/ 1520TA izquierdo (vista externa)*

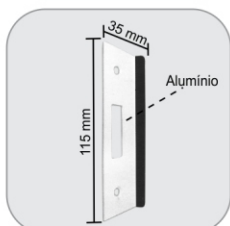
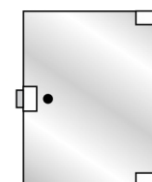

1504AX - Batedeira em alvenaria p/ 1520X (c/ borracha)
Tope en albañilería para 1520X

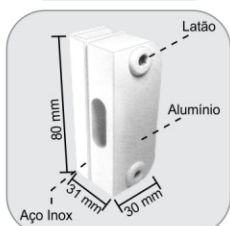
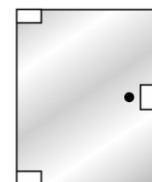

1504P - Contra fechadura de pressão para 1520P
Contra cerradura de presión para 1520P

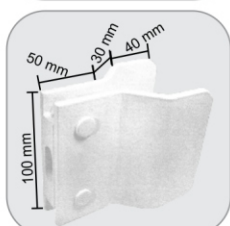
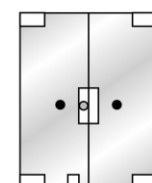

1504PX - Contra fechadura p/ 1520PX com puxador embutido
Contra cerradura para 1520PX con agarradera embutido

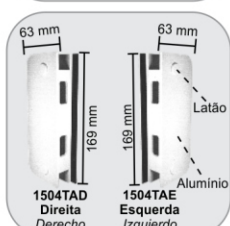
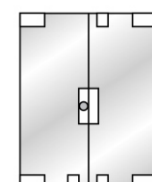

1504TA(D/E) - Contra fechadura s/ maçaneta (vidrio fixo) p/ 1520TA
Contra cerradura sin manija (vidrio fijo) para 1520TA

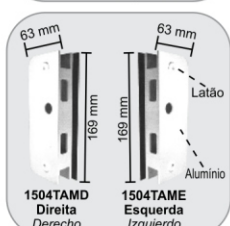
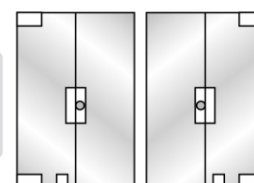

1504TAM(D/E) - Contra fechadura p/ maçaneta (2 portas) p/ 1520TA
Contra cerradura con manijas (2 puertas) para 1520TA

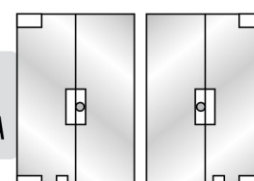



1504X - Contra fechadura para 1520X
Contra cerradura para 1520X

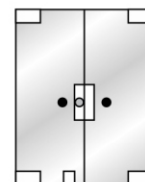

1504XP - Contra fechadura de pressão para 1520XP
Contra cerradura de presión para 1520XP

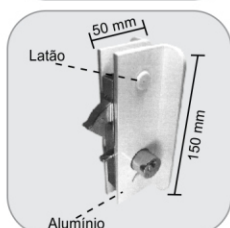
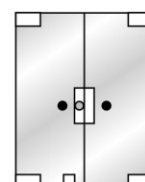

1510 - Fechadura bico-de-papagaio com pino e trava
Cerradura para puerta de correr con perno y traba

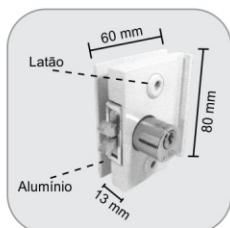
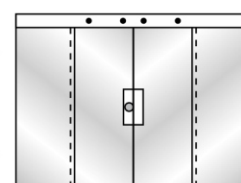

1510M - Mini fechadura c/ um cilindro p/ janela de correr
Cerradura pequeña p/ ventana de correr (llave de um lado)

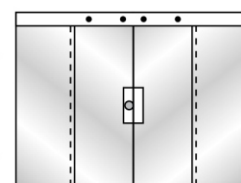

1510MP - Mini fechadura de pressão p/ janela de correr
Cerradura pequeña de presión para ventana de correr

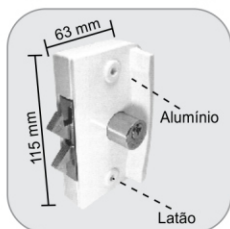
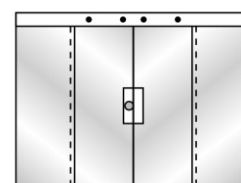

1510X - Fechadura com furação para porta de correr
Cerradura para puerta de correr

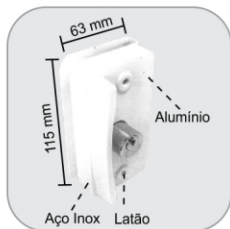
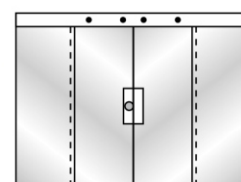

1510XP - Fechadura de pressão para porta de correr
Cerradura de presión para puerta de correr

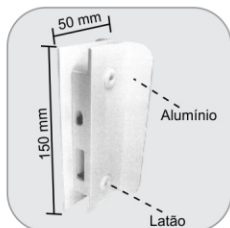
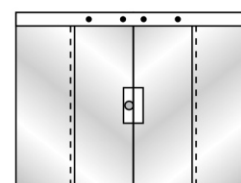

1511 - Contra fechadura com aba de proteção para 1510
Contra cerradura con ala para 1510

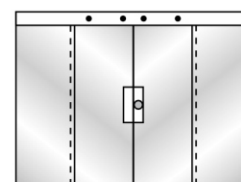

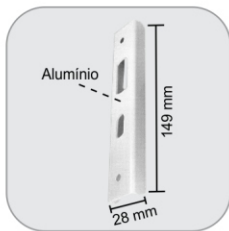

1511A - Testeira de parede para 1510
Chapa em albañilería para cerradura 1510

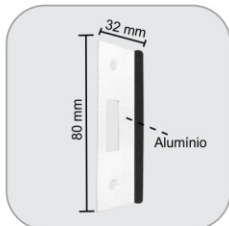
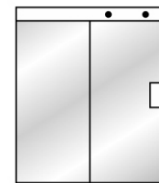

1511AM - Mini testeira para 1510M
Chapa pequena en albañilería para cerradura 1510M

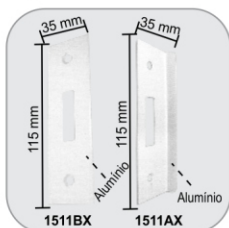
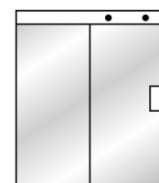

1511BX - Testeira para 1510X e 1520X no piso
1511AX - Testeira para 1510X

Chapa en el piso para cerradura 1510 y 1520 X
Chapa para cerradura 1510X

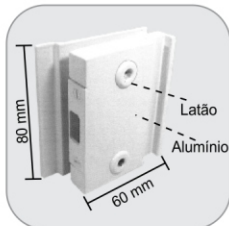
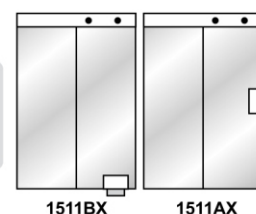

1511M - Mini contra fechadura c/ proteção p/ 1510M
Contra cerradura pequena con ala para 1510M

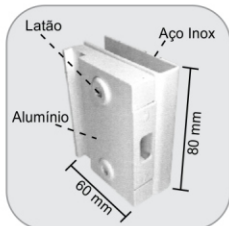
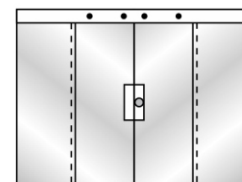

1511MP - Mini contra fechadura de correr de pressão p/ 1510MP
Contra cerradura pequena de presión para 1510MP

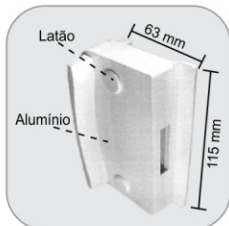
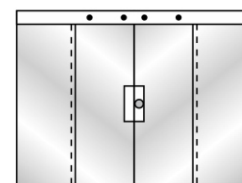

1511X - Contra fechadura para 1510X
Contra cerradura para 1510X

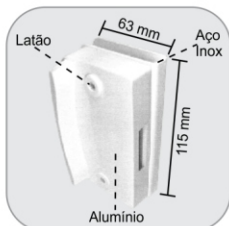
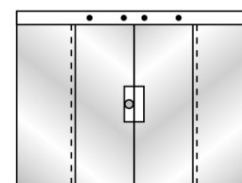

1511XP - Contra fechadura de pressão para 1510XP
Contra cerradura de presión para 1510XP

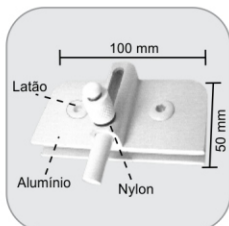
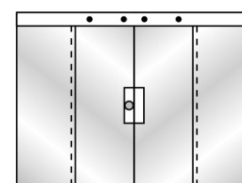

1519 - Trinco inferior sem núcleo 50x100 mm
Traba inferior sin núcleo 50x100 mm

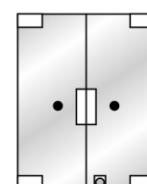

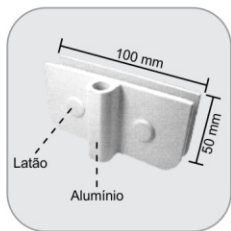

1519A - Contra trinco sem aba para 1519
Contra traba sin ala para 1519

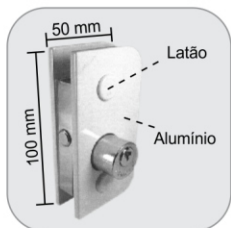
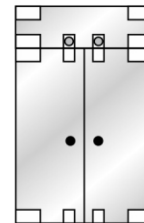

1520 - Fechadura central ou piso com 2 cilindros
Cerradura central y piso para puerta pivotante

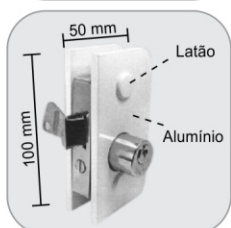
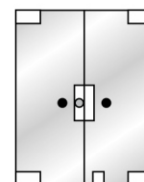

1520BF - Fechadura de centro bate-fecha
Cerradura con tope y cierra

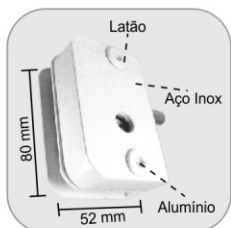
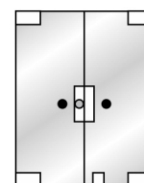

1520P - Fechadura de pressão com tetra chave
Cerradura de presión con llave tetra

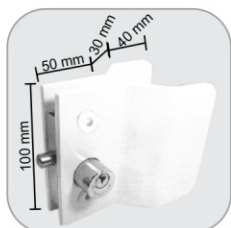
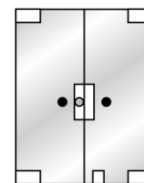

1520PX - Fechadura 1520 c/ puxador embutido
Cerradura 1520 con agarradera embutida

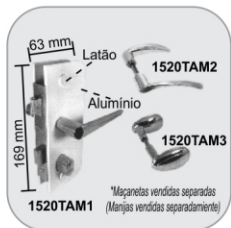
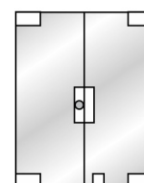

1520TA - Fechadura central p/ maçaneta c/ 2 cilindros
Cerradura para manijas

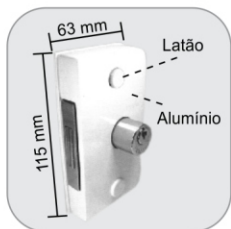
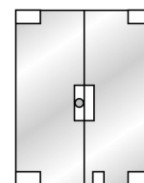

1520X - Fechadura reforçada p/ portas de abrir c/ furação
Cerradura reforzada para puerta pivotante

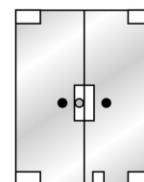

1520XP - Fechadura reforçada de pressão p/ porta de giro
Cerradura reforzada de presión para puerta pivotante

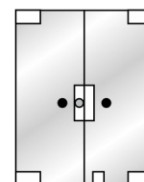

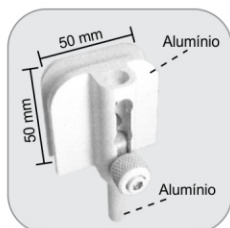

1521 - Trinco para janela ou porta
Traba para ventana y puerta

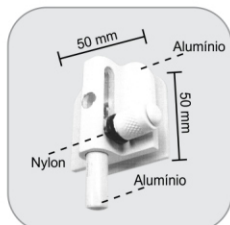
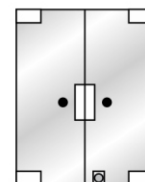

1521L - Trinco com ferrolho lateral
Traba de atornillar en la lateral

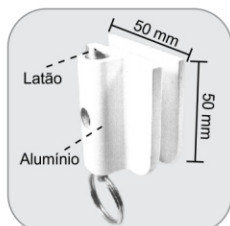
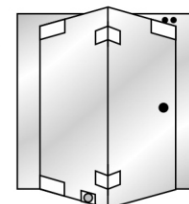

1523 - Trinco central para basculante
Traba para ventana pivotante

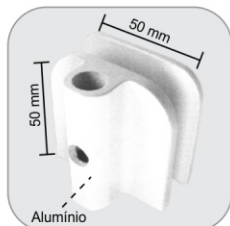

1524 - Contra trinco sem aba para 1521 e 1523
Contra traba sin ala para 1521 y 1523

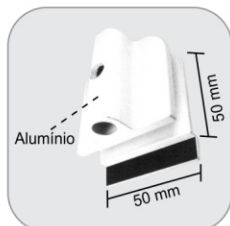
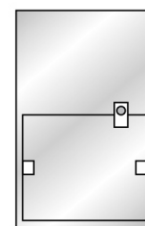

1525 - Contra trinco com aba p/ 1521 e 1523
Contra traba con ala para 1521 y 1523

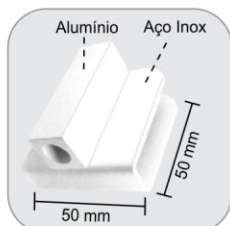
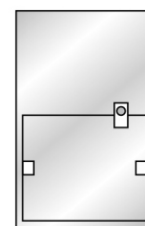

1529 - Contra trinco de pressão para 1800C
Contra traba de presión para 1800C

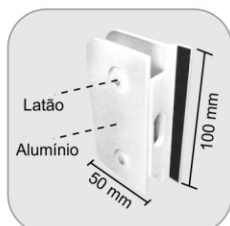
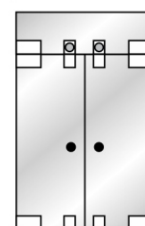

1531 - Contra fechadura com batente p/ 1520 e 1550
Contra cerradura con tope para 1520 y 1550

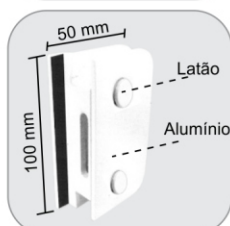
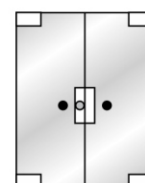

1531BF - Contra fechadura com batente para 1520BF
Contra cerradura con tope para 1520BF

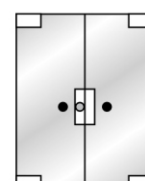

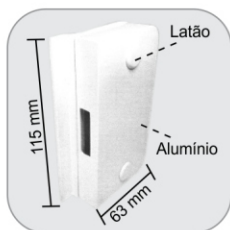

1531X - Contra Fechadura para 1520X
Contra cerradura para 1520X

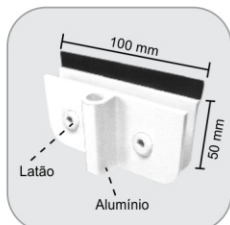
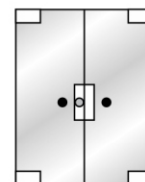

1532 - Contra trinco com aba para 1519
Contra traba con ala para 1519

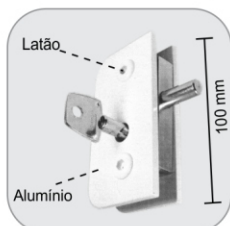
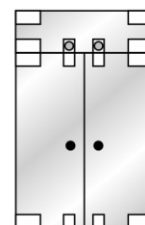

1550 - Fechadura central ou piso com tetra chave
Cerradura central y piso con llave tetra

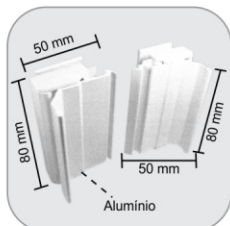
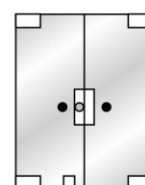

1570 - Fecho central V/V bate-fecha
Tope y cierra vidrio y vidrio

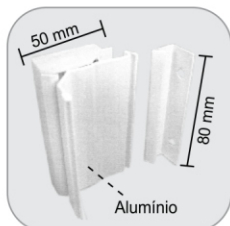
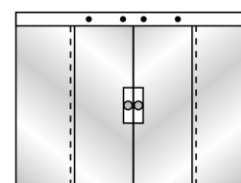

1571 - Fecho lateral V/A bate-fecha
Tope y cierra vidrio y albañilería

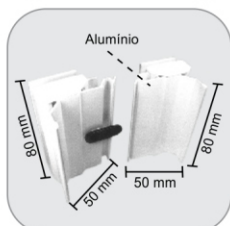
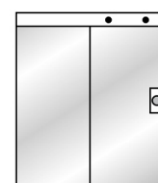

1572 - Fecho central V/V bate-fecha com trava
Tope y cierra vidrio y vidrio con traba

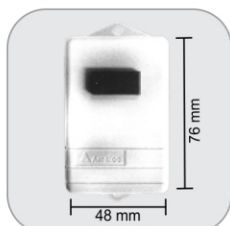
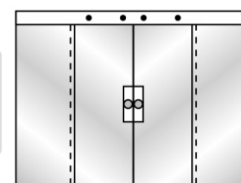

1579 - Acionador para fechadura eletrônica
Liberador para cerradura eletrônica

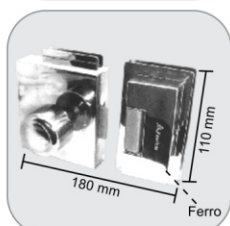
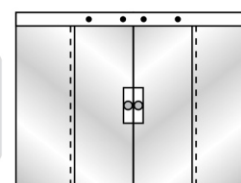

1580 - Fechadura elétrica V/V para recorte
Cerradura eléctrica vidrio y vidrio

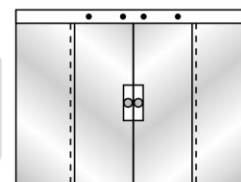

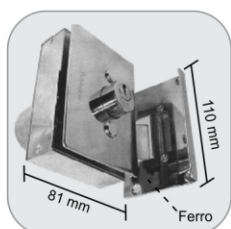

1581 - Fechadura elétrica V/A para recorte
Cerradura eléctrica vidrio y albañilería

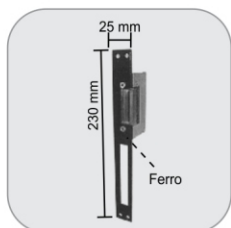
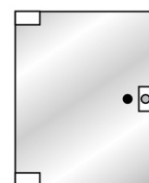

1582 - Fecho eletromagnético V/A
Traba electromagnética vidrio y albañilería

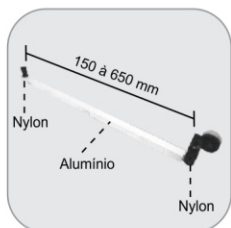
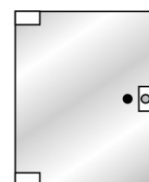

1587 - Haste para MAXIM-AR
Brazo para ventana de proyección



MEDIDAS (cm)

15 20 25 30 35 40 45 50 55 60 65

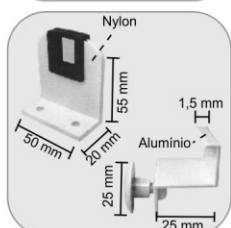

1587A - Conjunto acessório V/A para haste 1587
Acessorios vidrio y albañilería para brazo 1587

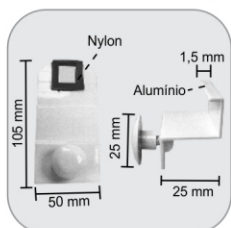

1587V - Conjunto acessório V/V para haste 1587
Acessorios vidrio y vidrio para brazo 1587

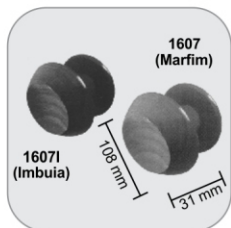
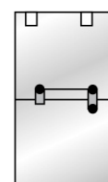

1607I - Puxador de madeira (cor Imbuía)
1607 - Puxador de madeira (cor marfim)

Agarradera de madera

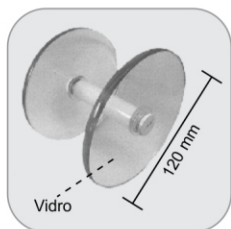
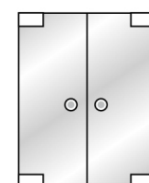

1608 - Puxador de vidro
Agarradera de vidrio

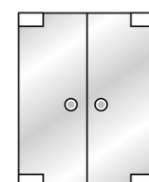

CORES (Colores)

1608 Incolor (Incoloro) 1609 Verde (Verde) 1610 Fume (Gris) 1611 Bronze (Bronce)

Puxador de resina
Agarradera de resina

CORES (Colores)

1612 Azul (Azul) 1613 Incolor (Incoloro) 1614 Verde (Verde) 1615 Fume (Gris) 1616 Bronze (Bronce) 1618 Branco (Blanco)

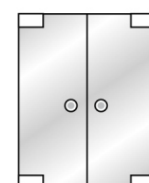

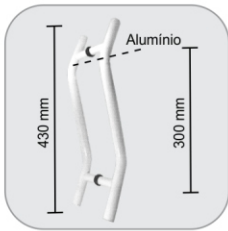

1617 - Puxador tubular em "S" (diâmetro - 25mm)
Agarradera en "S" (diámetro 25mm)

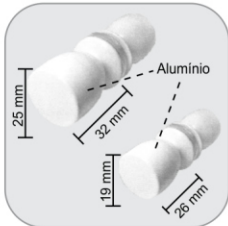
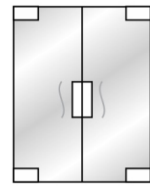

1629 - Puxador para box (25mm)
1630 - Puxador para box (19mm)

Agarradera para box

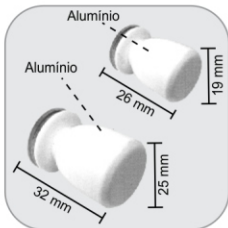
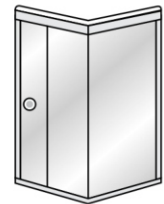

1650 - Puxador para janela de correr (25mm)
1651 - Puxador para janela de correr (19mm)

Agarradera para ventana de correr

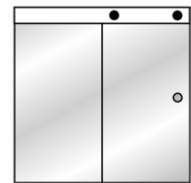

1660 - Distanciador para puxador de vidro 1608
Separador para agarradera de vidrio 1608

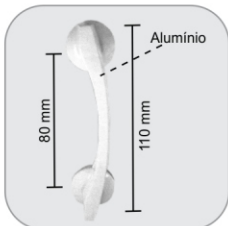
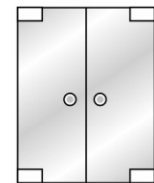

1670 - Puxador 1 lado p/ porta de correr (80mm entre furos)
Agarradera de 1 lado para puerta de correr (80mm entre agujeros)

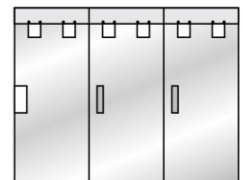

1670D - Puxador duplo p/ portas de correr (80mm entre furos)
Agarradera doble para puerta de correr (80mm entre agujeros)

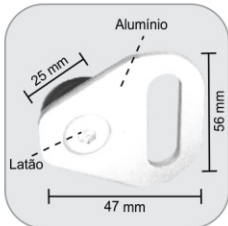
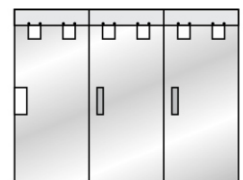

1671M - Mini puxador para transpasse portas e janelas com um furo

Agarradera pequena p/ puerta y ventana con 1 agujero (permite traspasar)

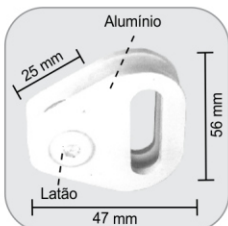
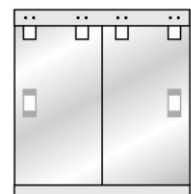

1671MD - Mini puxador duplo com transpasse para portas e janelas com um furo

Agarradera doble pequena para ventanas con 1 agujero (permite traspasar)

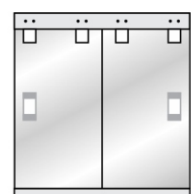

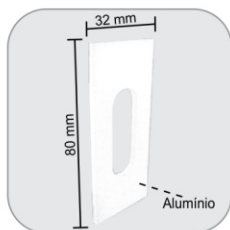

1672 - Puxador auto-adesivo para transpasse
Agarradera auto adhesivo (permite traspasar)

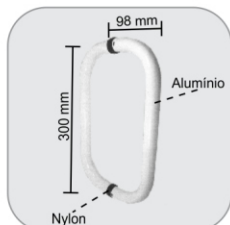
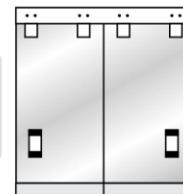

1676 - Puxador tubular com diâmetro de 25 mm (300 mm entre furos)
Agarradera con diámetro 25 mm (300 mm entre agujero)

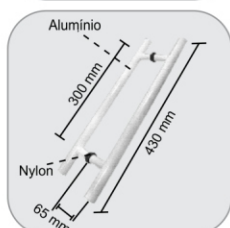
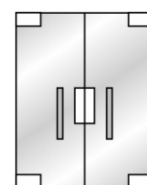

1679 - Puxador tubular reto 25 mm (300 mm entre furos)
1679A - Puxador tubular reto 25 mm (especial)

Agarradera recta - diámetro 25 mm (300 mm entre agujero)
Agarradera recta - diámetro 25 mm (especial)

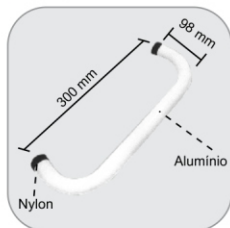
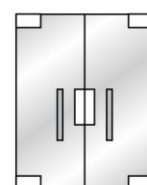

1680 - Puxador tubular p/ porta sanfonada (300 mm entre furos)

Agarradera para puerta sistema camarón (300 mm entre agujeros)

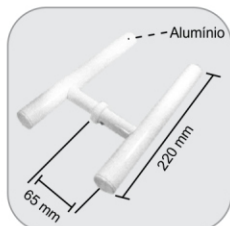
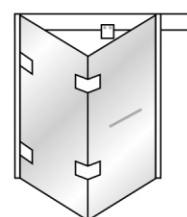

1696 - Puxador tubular tipo H (diâmetro 25 mm)
Agarradera "H" (Diámetro 25 mm)

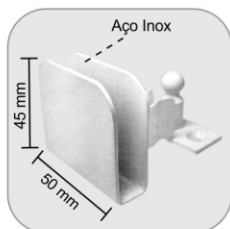
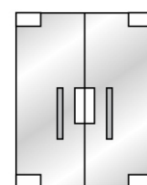

1702 - Fixador de porta no rodapé/piso
Fijador de puerta en la pared y piso

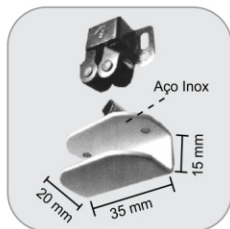

1704 - Fixador de pressão para portas de extintores
Fijador de presión para puerta de aparato contra incendios

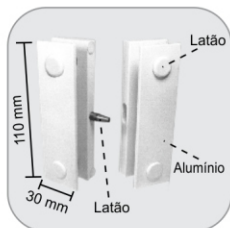

1710 - Conjunto mão-de-amigo p/ portas de correr com 1030
Sistema de trabar y tirar para puertas de correr con perfil 1030

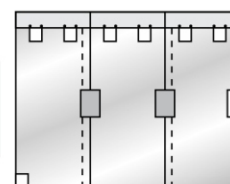

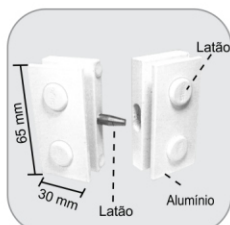

1710M - Mini conjunto mão-de-amigo p/ portas de correr com 1030

Sistema pequeno de trabar y tirar para puertas de correr con perfil 1030

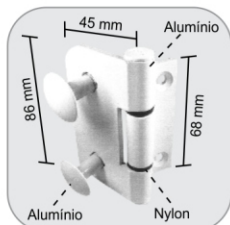
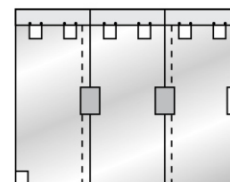

1750 - Dabradiça simples para madeira/alvenaria

Bisagra para vidro y madera o vidrio y albañilería

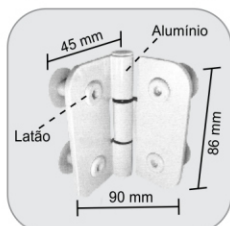

1751 - Dobradiça dupla granito/madeira/vidro

Bisagra para vidro y vidrio, vidrio y madera o vidrio y granito

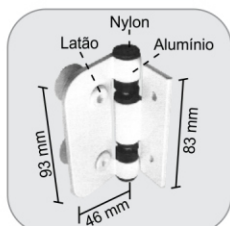
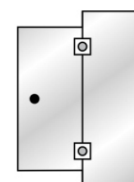

1755 - Dobradiça automática madeira/alvenaria/vidro

Bisagra automática vidro y madera o vidrio y albañilería



1756 (D/E) - Dobradiça automática dupla granito/madeira/vidro

Bisagra aut. vidro y vidrio, vidrio y madera o vidrio y granito

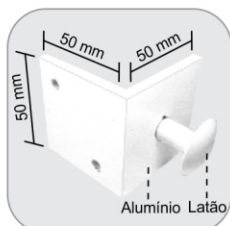
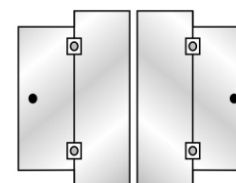

1760 - Cantoneira granito/alvenaria

Esquinera vidro y albañilería o vidrio y granito

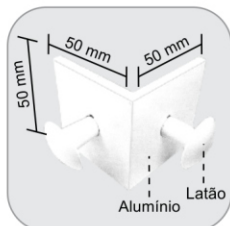

1761 - Cantoneira granito/granito

Esquinera granito y granito

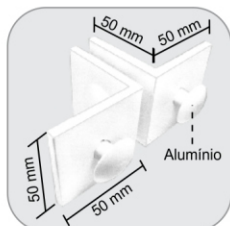
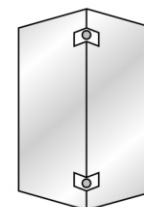

1762 - Cantoneira dupla granito/granito

Esquinera doble granito y granito

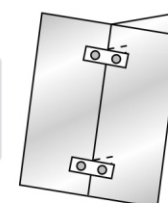

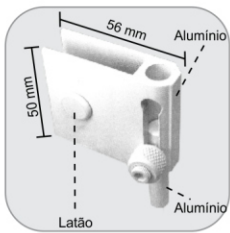

1800 - Trinco para janela de correr
Traba para ventana de correr

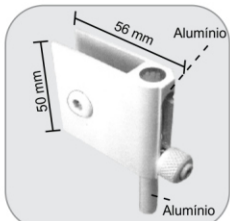
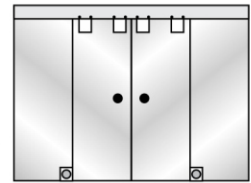

1800A - Trinco para janela de correr
Traba para ventana de correr

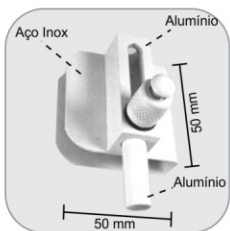
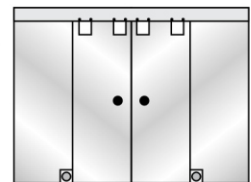

1800B - Trinco de pressão para janela de correr
Traba de presión para ventana de correr

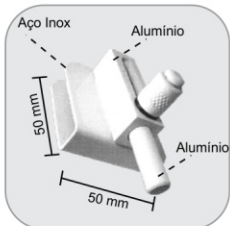
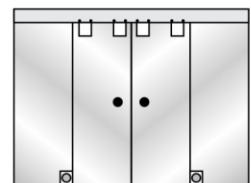

1800C - Trinco de pressão sem núcleo
Traba de presión sin núcleo

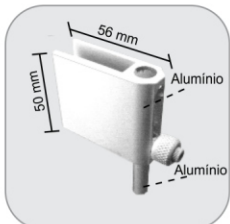
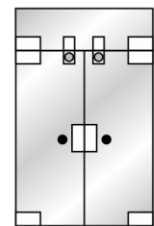

1800AS - Trinco de pressão para janela de correr
Traba de presión para ventana de correr

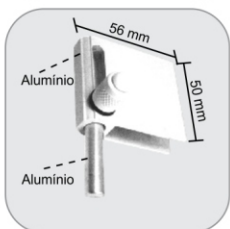
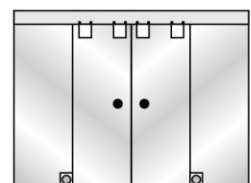

1800S - Trinco de pressão para janela de correr
Traba de presión para ventana de correr

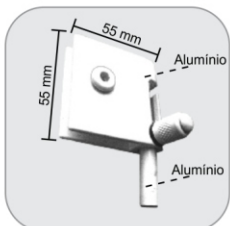
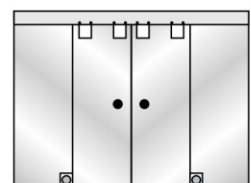

1810D - Trinco direito para janela de correr
Traba derecha para ventana de correr

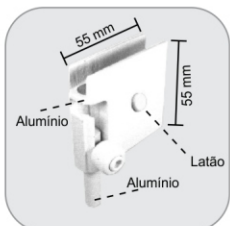
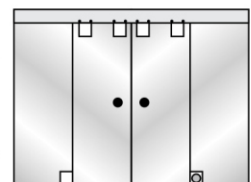

1810E - Trinco esquerdo para janela de correr
Traba izquierda para ventana de correr

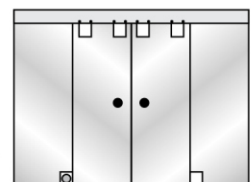

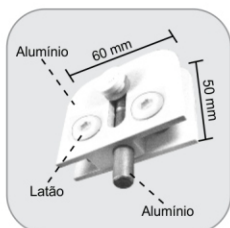

1813J - Trinco p/ janela de correr que permite transpasse
Traba para ventana de correr (permite traspasar)

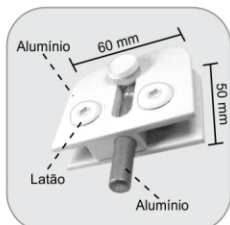
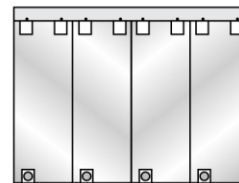

1813P - Trinco p/ porta de correr que permite transpasse
Traba para puerta de correr (permite traspasar)

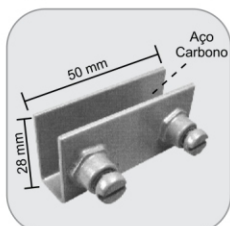
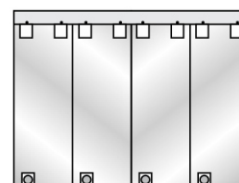

1906 - Suporte p/ mola aérea (bandeira) (dispensa recorte)
Soporte para bisagra hidráulica aérea (banderola)

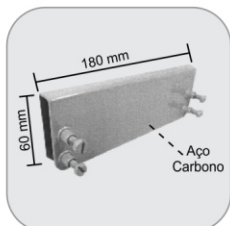
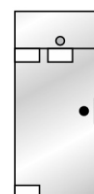

1906P - Suporte p/ mola aérea (porta) (dispensa recorte)
Soporte para bisagra hidráulica aérea (puerta)



1912 - Fechadura morcego para vitrines
Cerradura para vitrina

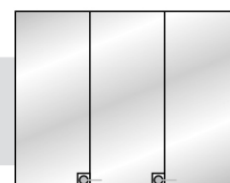

1913 - Fechadura "só cilindro" para rack
Cerradura para mueble

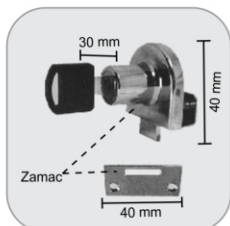

1913P - Fechadura de pressão com lingueta para rack
Cerradura de presión para mueble



Guias e amortecedores
Guías y amortiguador



1404 - Guia de nylon para porta de correr
Guía de nylon para puerta de correr



1405 - Amortecedor reto de borracha 12x25 mm
Amortiguador recto de caucho 12x25 mm



1406 - Amortecedor curvo de borracha 15x17 mm
Amortiguador curvo de caucho 15x17 mm

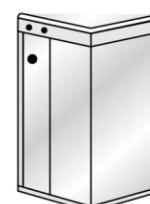



BORRACHAS E ESCOVAS

Perfil de vinil

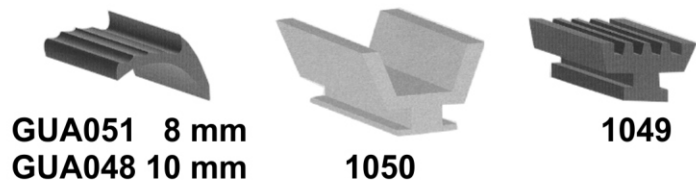

GUA051 8 mm
GUA048 10 mm

1050

1049



Escovas Cód. BxH (mm)	
1038 5x5	1038E 5x10
1038A 5x7	1038F 7x12
1038B 7x10	1038G 7x7
1038H 7x10 adesiva	

SPIDER Arañas



SPIDER 1
Arañas de 1 punta



SPIDER 2
Arañas de 2 puntas



SPIDER 3
Arañas de 3 puntas



SPIDER 4
Arañas de 4 puntas

VENTOSAS



1923

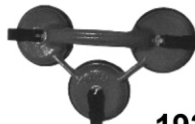

1924

PARAFUSOS E SUPORTES

Tornillos y Acoples para repisas



Suporte para prateleira 2001
(Acople para Repisas)

MODELO/MEDIDAS
1703 - A 06 mm
1703 - B 08 mm
1703 - C 10 mm



1033A



2003L
(latão)
latón

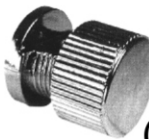

2002P
(plástico)

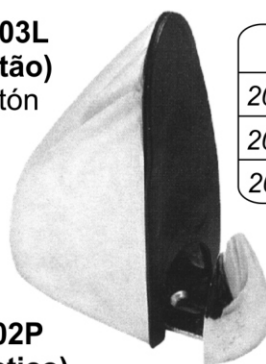

TUCANO (Clipo)
2009 - Pequeno (Pequeño)
2009A - Médio (Mediano)
2009B - Grande (Grande)

TINTAS, SILICONES E APLICADORES

Tintas, silicon y pistola calafateadora



COLOR (Colores)
Branco (Blanco)
Preto (Negro)
Bronze (Bronce)
N. Fosco (Opaco)



SILICONES acético Silicon acético	SILICONES neutro Silicon neutral
Incolor (Incoloro)	Incolor (Incoloro)
Branco (Blanco)	Preto (Negro)
Bronze (Bronce)	
Preto (Negro)	
Alumínio (Aluminio)	

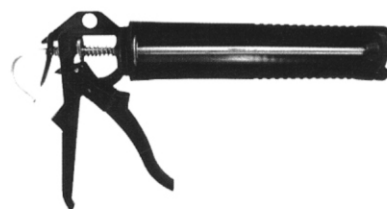

PERFIL DE ALUMÍNIO

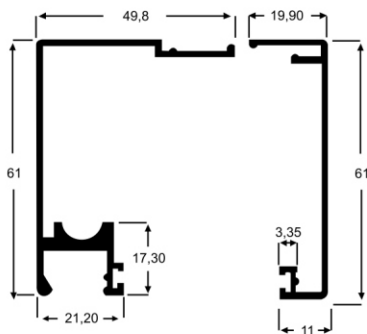

1021
0,729 Kg/m

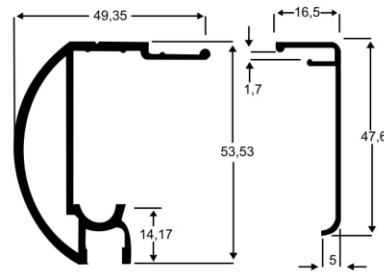

1022
0,268 Kg/m

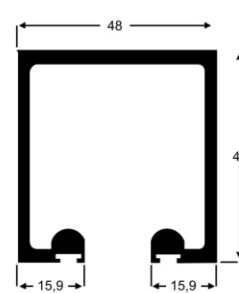

1021-BX
0,717 Kg/m

1022-BX
0,214 Kg/m

1030
1,209 Kg/m

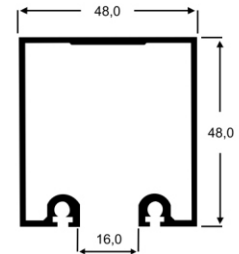

1030-L
0,881 Kg/m

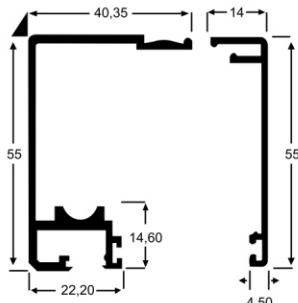

1021-L
0,650 Kg/m

1022-L
0,231 Kg/m

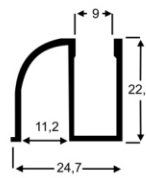

1016-BX
0,236 Kg/m

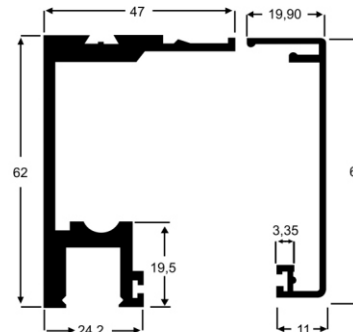

1041
1,192 Kg/m

1042
0,370 Kg/m

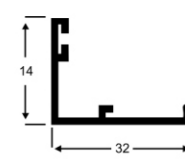

3211
0,245 Kg/m

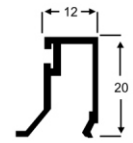

3210
0,175 Kg/m

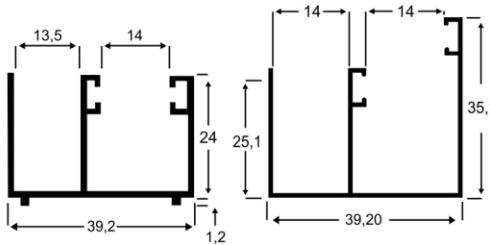

1034
0,411 Kg/m

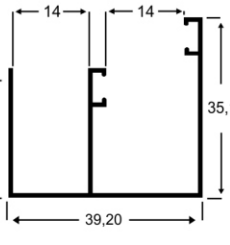

1034-A
0,455 Kg/m

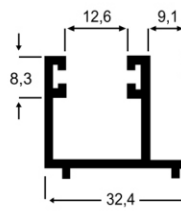

1034-C
0,357 Kg/m

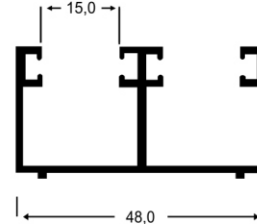

1034-D
0,522 Kg/m

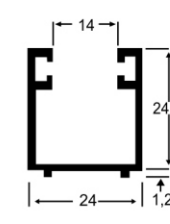

1034-S
0,345 Kg/m

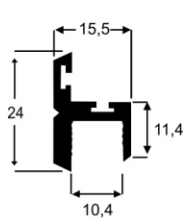

1035-B
0,260 Kg/m

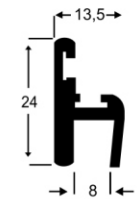

1035
0,242 Kg/m

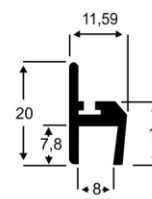

1035-C
0,141 Kg/m

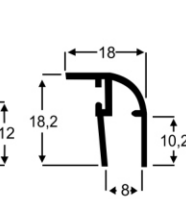

1035-BXC
0,137 Kg/m

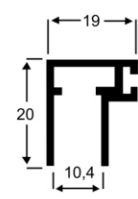

1039-B
0,239 Kg/m

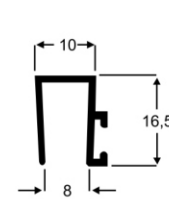

1039
0,166 Kg/m

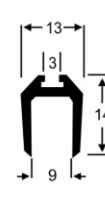

1036
0,148 Kg/m

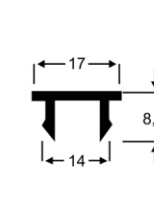

1033
0,097 Kg/m

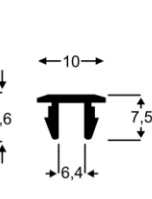

1015
0,097 Kg/m

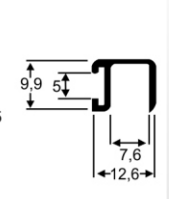

1039-BX
0,094 Kg/m

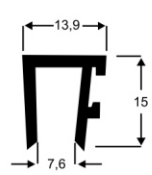

1039-C
0,149 Kg/m

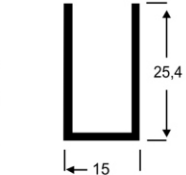

1019
0,210 Kg/m

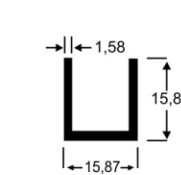

1018
0,173 Kg/m

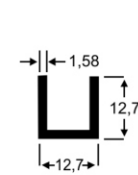

1037
0,155 Kg/m

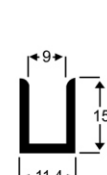

1037-A
0,118 Kg/m

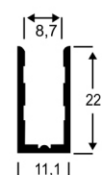

1037-C
0,157 Kg/m

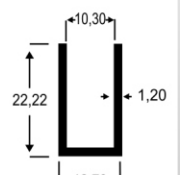

1020
0,181 Kg/m

PERFIL DE ALUMÍNIO

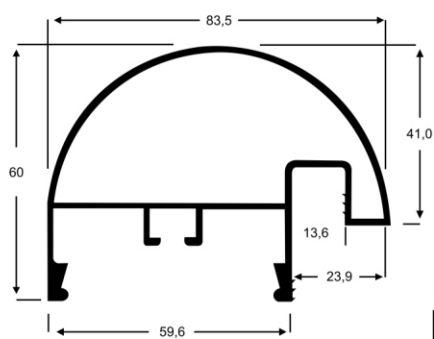

1084
1.098 Kg/m

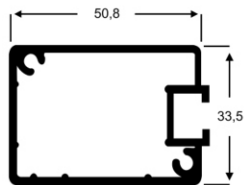

1077
0.813 Kg/m

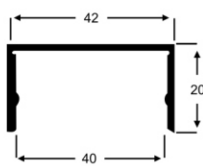

4030-A
0.241 Kg/m

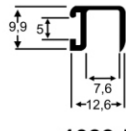
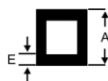

1039-BX
0.094 Kg/m

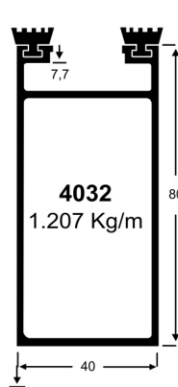

4032
1.207 Kg/m

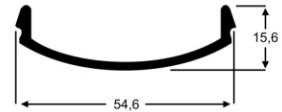

1074
0.417 Kg/m

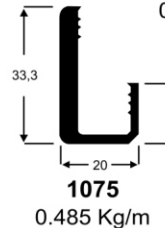

1075
0.485 Kg/m

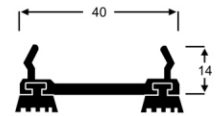

4031
0.376 Kg/m



Tubos Retangulares

CÓDIGO	A (mm)	B (mm)	C (mm)	PESO (Kg/m)
1031	50,80	25,40	1,58	0,635
1026	76,20	38,10	1,58	0,922
1027	101,60	50,80	2,00	1,583
1027-A	95,00	50,80	1,60	1,261

Tubos Quadrados

CÓDIGO	A (mm)	E (mm)	PESO (Kg/m)
1029	50,80	1,58	0,818

Cantoneiras de Abas Iguais

CÓDIGO	A (mm)	E (mm)	PESO (Kg/m)
1080	12,70	1,58	0,102
1081	15,87	1,58	0,124
1082	25,40	1,58	0,151
1083	19,50	1,58	1,216

PLANEJAMENTO

IMPORTANTE:

AS FOLGAS APLICADAS VARIAM CONFORME PLANEJAMENTO/INSTALADOR, PORTANTO AS FOLGAS INDICADAS NESTE CATÁLOGO TÉCNICO SERVEM APENAS COMO REFERÊNCIA E ORIENTAÇÃO

FURAÇÃO PARA JANELA:

ALTURA PARA PUXADORES OU FECHADURAS:
 Altura até 400 mm = 150 mm
 Altura até 600 mm = 200 mm
 Altura até 1000 mm = 300 mm
 Altura até 1200 mm = 400 mm
 Altura acima de 1200 mm = 500 mm ou conforme PCP determinar

OBSERVAÇÃO:

QUANDO O CLIENTE NÃO COLOCAR AS COTAS, SEMPRE SERÁ ADOTADO O PADRÃO DA EMPRESA

PLANEJAMENTO FIXOS

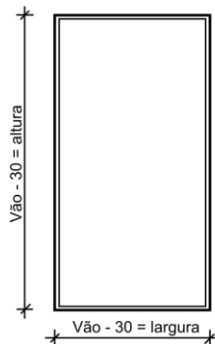

Uso do perfil 1019

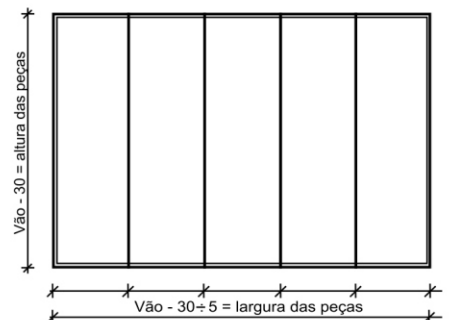
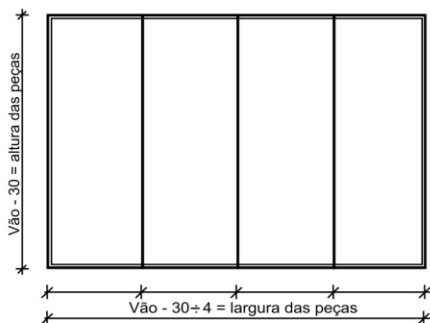
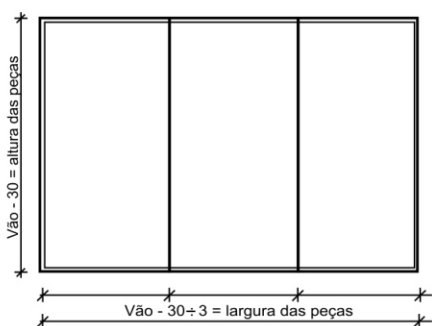
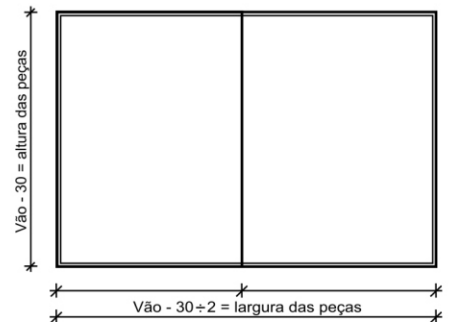
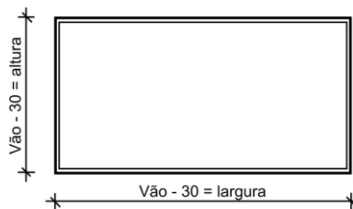

PLANEJAMENTO

Box correr/ abrir

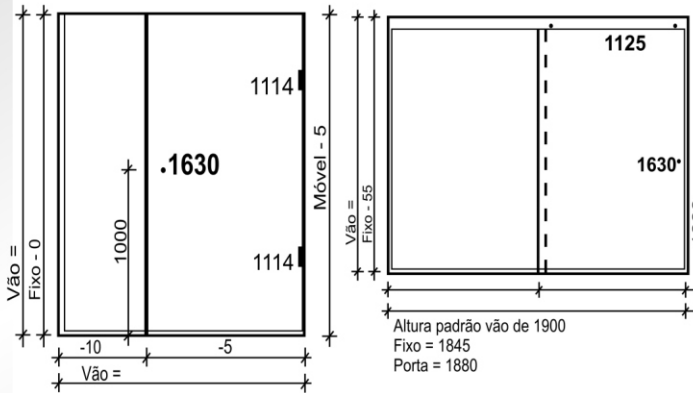

PLANEJAMENTO

Box abrir canto/frontal

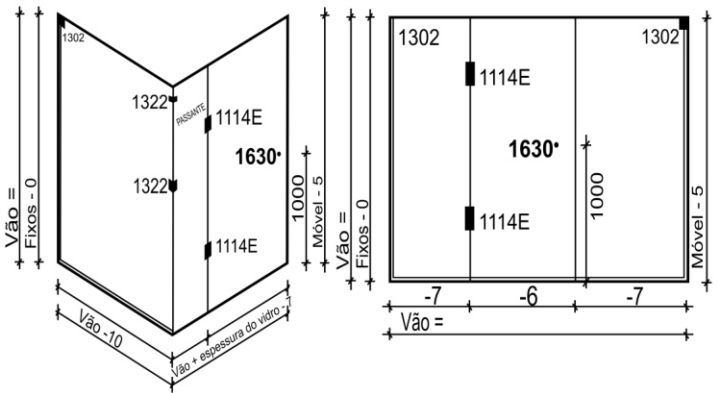

PLANEJAMENTO

Porta abrir

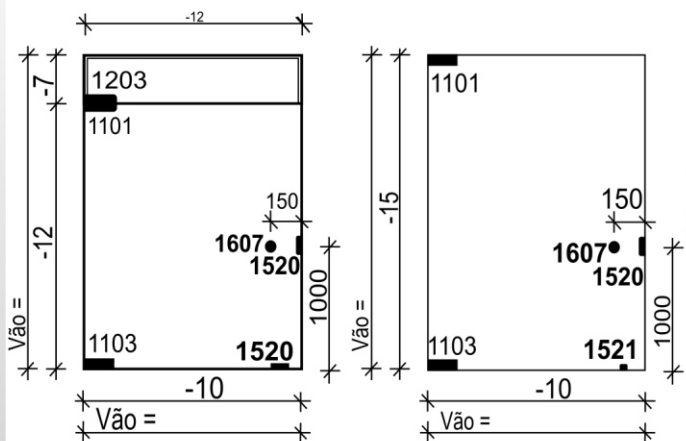

PLANEJAMENTO

Basculante Pivotante

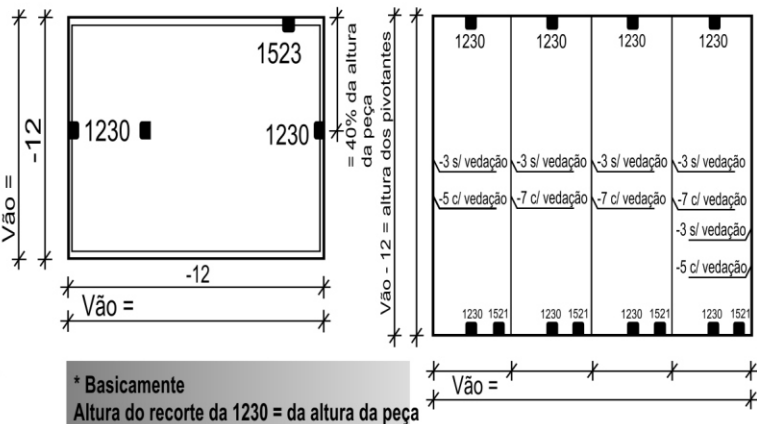

PLANEJAMENTO

Porta + Fixo

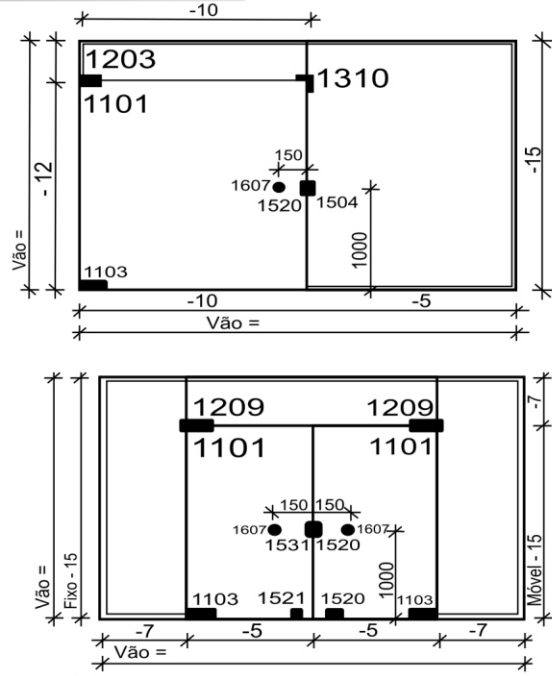
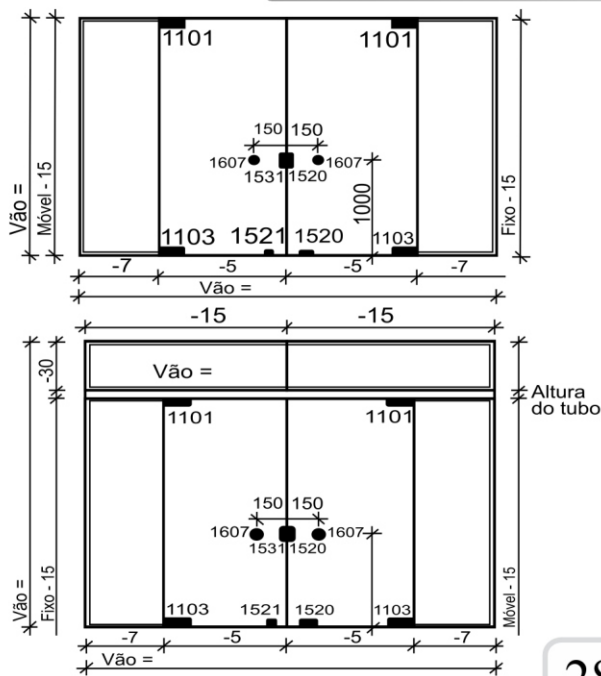

PLANEJAMENTO Basculante + fixo

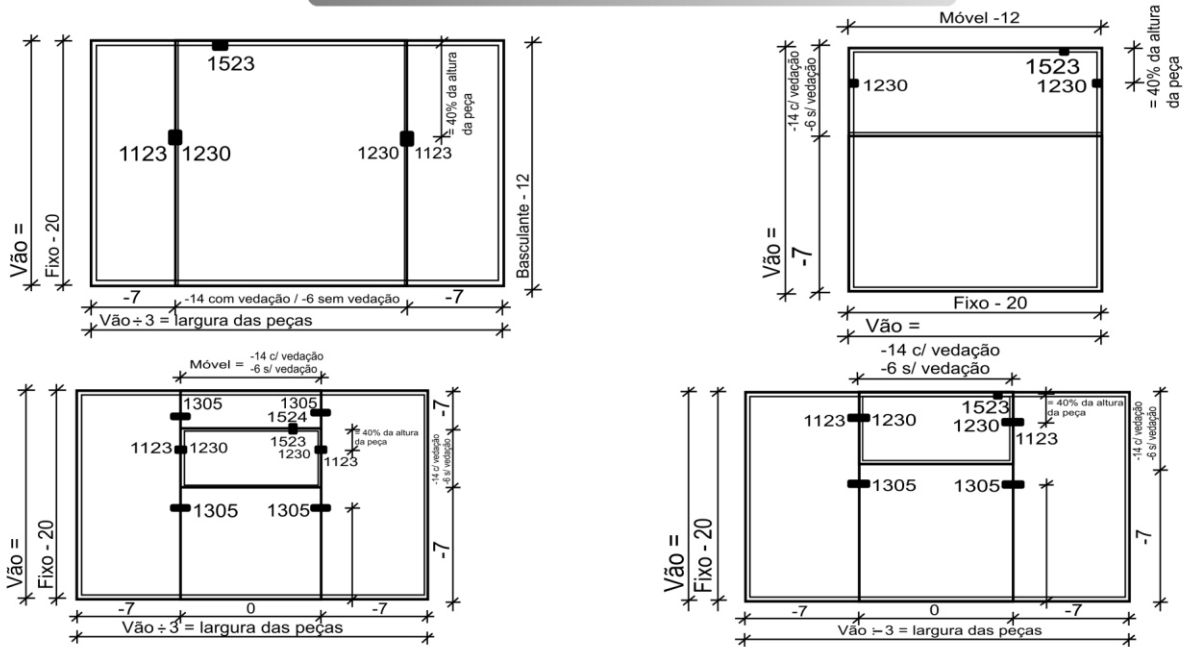

PLANEJAMENTO Maxin-Ar + Fixo

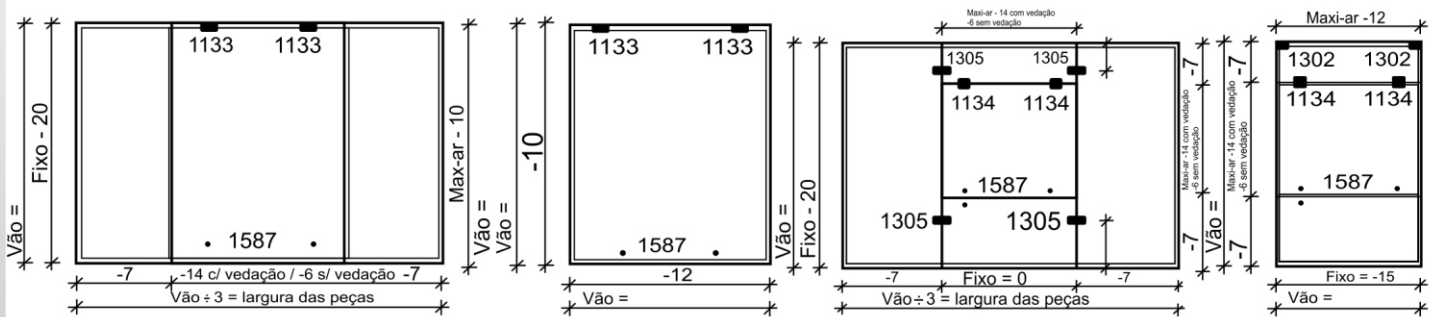

PLANEJAMENTO Conjunto de Correr

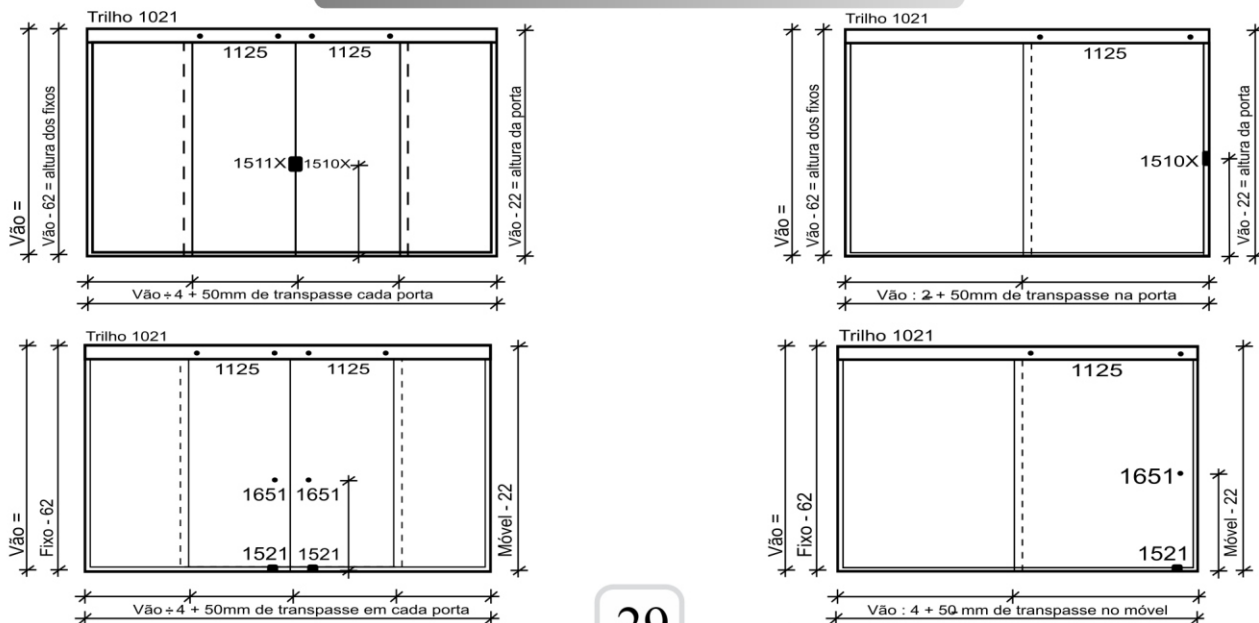

World Fer - Ferragens para vidros temperados
Rua SF 019, nº 110 - Bairro Cerâmica Reis
CEP: 88355-425 - Brusque - SC
Fone/Fax: (47) 3396-0609 / 3355-6558
E-mail: wfferragens@hotmail.com

Padrão de cores



BRANCO



AZUL



VERMELHO



VERDE



DOURADO



AMARELO

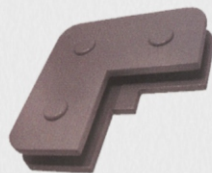

CINZA GRAFITE



PRETA

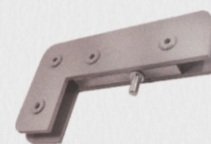

CINZA

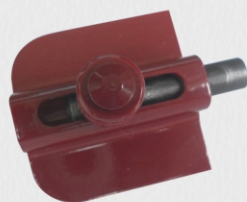

VINHO

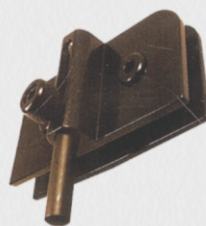

BRONZE



BEGE